



**Foamstream**  
— M600 —

## QUICK START-UP GUIDE

ENGLISH – 16/05/2018 – ISSUE 3



## Safety Information

To ensure safety while operating the M600, please carefully read the following information.

### Operator Attention

#### **WARNING**

- Read and understand this user manual before operating the M600.
- The M600 should only be used by trained operators.
- Proper PPE is to be worn at all times while operating the M600.
- Major repair work should only be carried out by professionally trained technicians.

### Carbon Monoxide Hazards

#### **WARNING**

- Boiler and generator exhaust contains poisonous carbon monoxide gas.
- Never run the M600 indoors, even if a door or window is open. **ONLY USE IN A WELL VENTILATED AREA.**
- Do not use the M600 in potentially explosive atmospheres.

### Electric Shock Hazards

#### **WARNING**

- Do not operate the M600's electrical components with wet hands.
- Do not expose the generator to rain, moisture, or snow.
- Always ensure electric cables are in good condition.

### Fire and Burn Hazards

#### **WARNING**

- LPG and diesel are explosive and flammable. Always ensure spark or fire source point away while refueling.
- Do not refill diesel while machine is in use.
- Clean up any overflowing fuel prior to turning on the M600.
- Never smoke while operating the M600.
- Do not touch the working components in the M600 while in use or immediately following use. Allow sufficient time to cool before servicing.
- Shut off generator by closing LPG supply to prevent unburned gas from remaining in the system.

### Generator Fuel Warning

#### **WARNING**

**NEVER USE GASOLINE IN THE M600. ONLY USE LPT TO FUEL THE GENERATOR.**

If the generator is used outside the M600 as a backup generator and gasoline is used, follow the instructions below prior to using the M600.

- **Remove all remaining gasoline from generator and clean all spills and allow to dry/evaporate before putting the generator back inside the M600.**
- Turn the fuel switch (item 7 in Figure 3) to the **OFF** position.
- Connect LPG cylinder and start as normal.

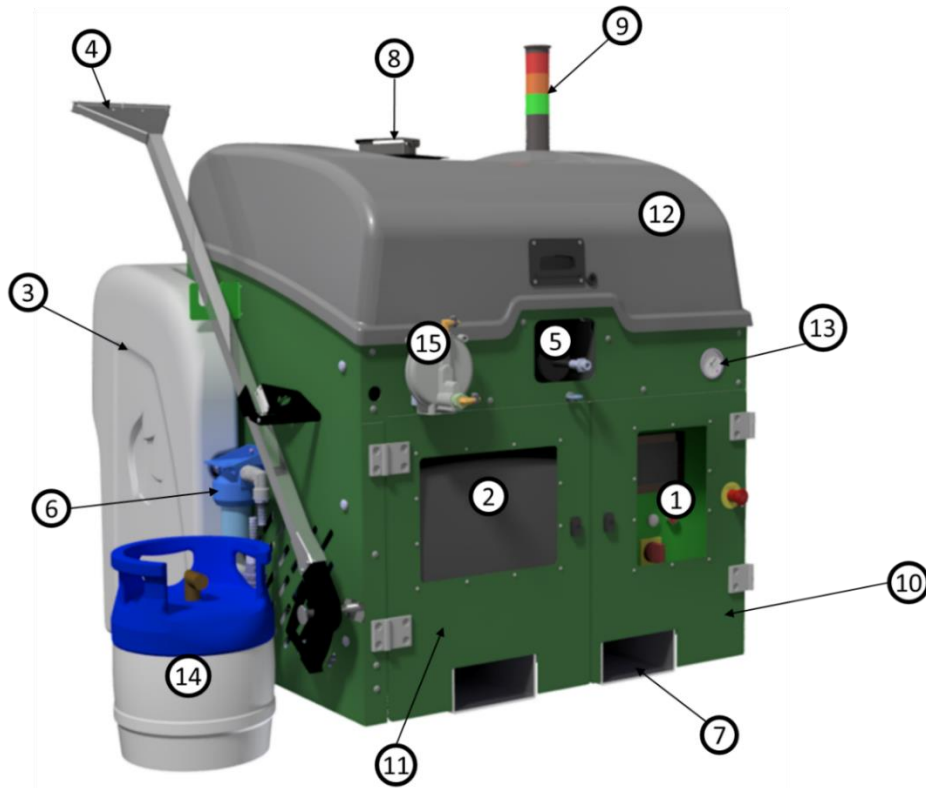

Num.	Description
1	Control Panel
2	Generator
3	Water tank
4	Wand
5	Hose reel orifice
6	Water Filter
7	Forks entrance
8	Boiler exhaust flap
9	Warning light
10	Control panel access door
11	Generator access door
12	Top cover
13	Hydraulic pressure gauge
14	LPG cylinder
15	LPG regulator

Figure 1 - Perspective view of the M600

## Prestart checks

THE FOLLOWING CHECKS MUST BE COMPLETED BEFORE EVERY START UP OF THE M600. ANY FAULTS MUST BE RECTIFIED BEFORE THE M600 IS SWITCHED ON.

- ✓ The M600 is in good condition and securely attached to the transport vehicle
- ✓ The M600 water tank is securely attached to the transport vehicle
- ✓ The LPG cylinder is full, secured, and in good condition
- ✓ Water tank is full of clean water
- ✓ Water filter is clean and free from debris
- ✓ Air intakes are clear of debris
- ✓ The wand, hose reel and hose are securely connected and free from damage
- ✓ Wand wear pads are not excessively worn
- ✓ The water return pipe and water level sensor are connected
- ✓ Pipe/hose routes are clear of sharp edges and hot surfaces
- ✓ There are no signs of leaks from any pipe or connection
- ✓ Fuel tank is full of clean diesel fuel
- ✓ Boiler fuel filter is clean and free from debris
- ✓ The Foamstream® concentrate has not been subject to temperatures below 41°F and frozen or separated
- ✓ Foamstream® concentrate tank is full of clean Foamstream® concentrate
- ✓ Foamstream® filter is clean and free from debris
- ✓ Vent screw on Foamstream® tank filler cap is open
- ✓ Generator engine oil level is correct
- ✓ Pump oil level is correct
- ✓ Generator and boiler exhaust are secure and clear of debris and obstruction
- ✓ Fuel switch on generator is in the OFF position
- ✓ Generator is switched to normal mode
- ✓ Water feed valve is connected and in the ON (inline) position
- ✓ Air has been bled from water system
- ✓ The LPG cylinder valve is connected and open

**NOTE:**

**CLOSE LPG CYLINDER VALVE WHEN MACHINE IS NOT IN OPERATION**

**NEVER RUN GENERATOR WITH LPG WHILE GASOLINE REMAINS IN THE GASOLINE TANK.**

## Filling with foam and Diesel

NEVER MIX FOAMSTREAM® CONCENTRATE WITH DIESEL.  
ONLY FILL FOAM TANK WITH FOAMSTREAM® CONCENTRATE.

- ✓ Open top cover and prop up with rod.
- ✓ To fill diesel tank, open valve cap (RED - LEFT) (item 1 Figure 2) and carefully pour diesel until the tank is full.
- ✓ Replace cap and screw in until tight.
- ✓ To fill foam tank, open valve cap (GREEN - RIGHT) (item 2 Figure 2) and carefully pour Foamstream® concentrate until the tank is full.
- ✓ Replace cap and screw in until tight.

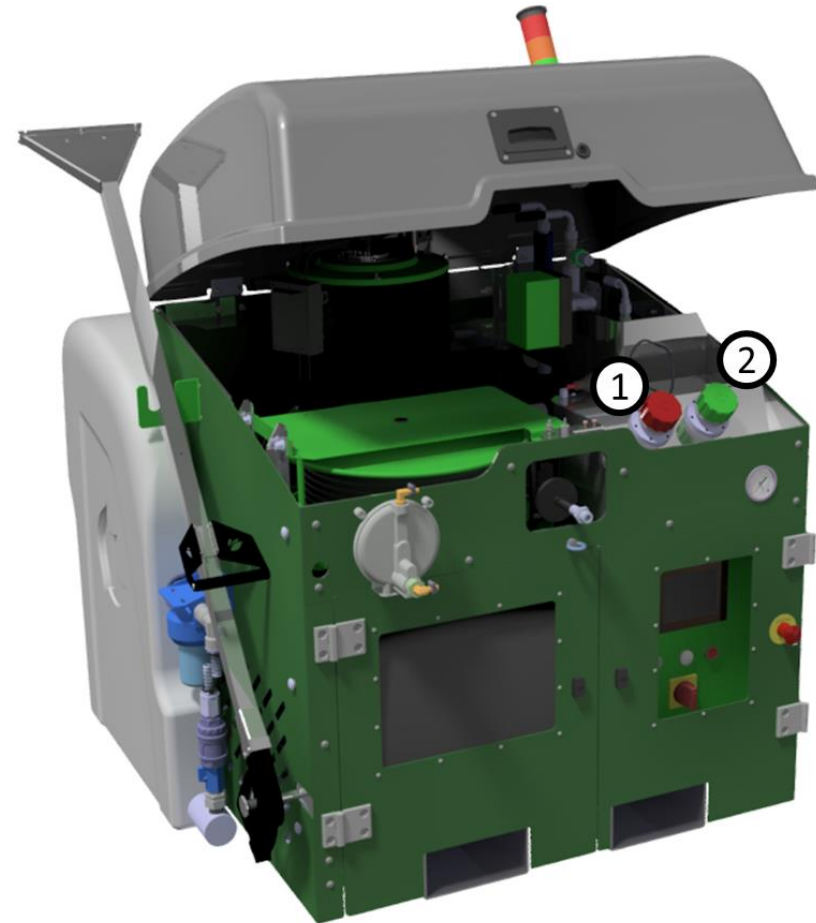

Figure 2 - View of foam and diesel filling points

## Start procedure

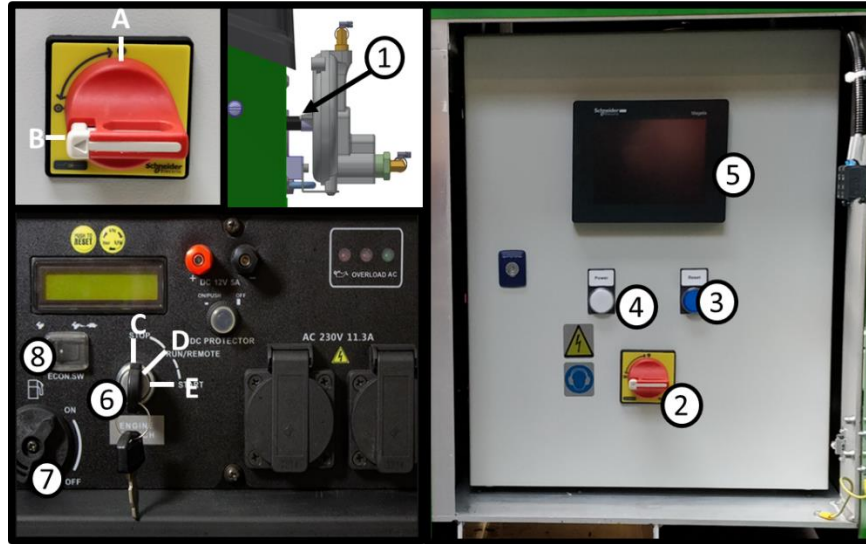

Figure 3 - M600 User Interface

- ✓ Complete pre-start checks (previous section)
- ✓ Press and hold priming button on regulator (item 1 in Figure 3)
- ✓ Turn fuel switch to **OFF** position on generator (item 7 in Figure 3)
- ✓ Start the generator by turning key (item 6 in Figure 3) in a clockwise direction by either:
  1. Turn key to position **E**, release to position **D** when engine starts
  2. Turn key to position **D** and double press and hold **ON** on the remote (Not shown)
- ✓ Turn the isolator switch (item 2 in Figure 3) to position **A**, the PLC screen (item 5 in Figure 3) should illuminate

- ✓ Press the **RESET** button (blue button, item 3 in Figure 3), the **FAULT** indicator goes out and you should see the screen represented in Figure 4.

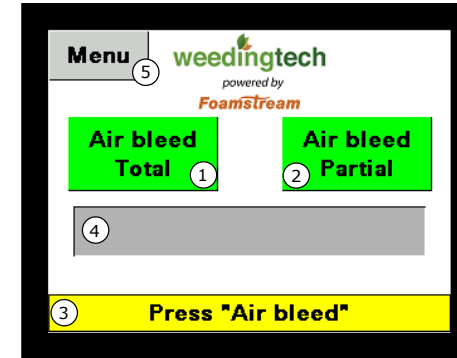

Figure 4 - Start-up screen of the PLC

- ✓ Wait a few seconds before requesting air bleed: buttons **1** or **2** in Figure 4.

If you have disconnected the water tank or are starting for the first time of the day, please use **Air bleed Total**

If you just took a break or want to perform an additional air bleed, please select **Air bleed Partial**

When bleeding the machine, the **trigger must be pushed** to allow water to flow out of the wand. Failure to do so will cause the machine to display a fault message.

- ✓ Once button **1** or **2** of Figure 4 are pressed the bleed screen represented in Figure 5 will appear.

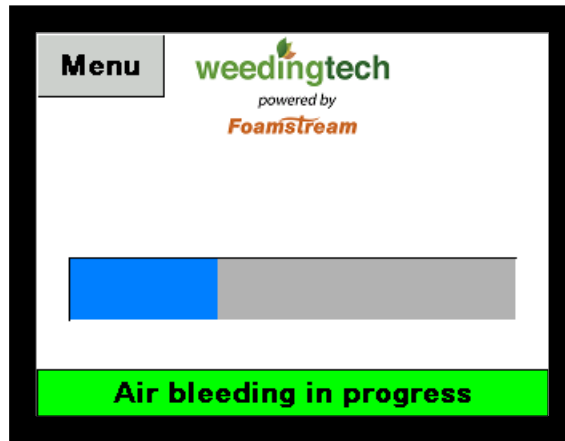

Figure 5 - Bleed screen of the PLC

**If starting when water tank level is below water filter level perform either of the following:**

1. Fill water tank to higher level than water filter
  2. If unable to fill water tank select scenario below and follow the instructions
    - ✓ Water filter full, no air in system - Machine will start like normal.
    - ✓ Water filter full, air in system - Perform an additional air bleed.
    - ✓ Water filter empty - Manually fill water filter and then replace, then perform additional air bleeds until no faults/errors appear on the screen ("No flow at outlet" "Release Trigger") then perform one additional air bleed to ensure system is free of air.
- ✓ Wait until the purge is completed. A new screen will appear, represented in Figure 6.

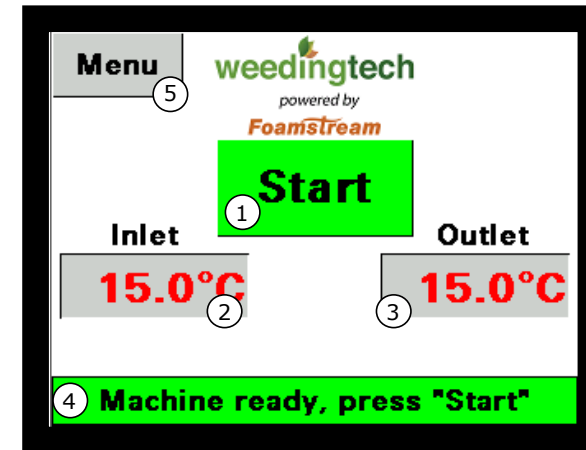

Figure 6 - Start screen of the PLC

- ✓ Press **START**, the button turns green and the screen represented on Figure 7 will appear.

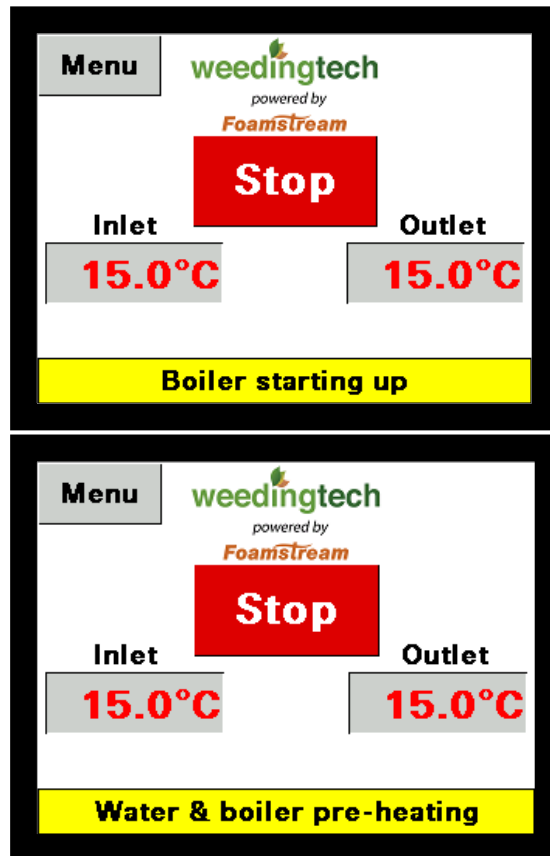

Figure 7 - Running screen of the PLC

AFTER A COLD NIGHT (BELOW 32 DEGREES FAHRENHEIT), LET THE GENERATOR RUN ALONE FOR 15 MINUTES TO WARM UP THE MACHINE BEFORE TURNING THE ISOLATOR TO POSITION **A**.

- ✓ The orange **HEATER** light will illuminate and the red **FAULT** button should go out. This indicates that the boiler has switched on and is heating the water
- ✓ The green **READY** light will illuminate when the M600 has reached operating temperature and the system is ready for use (2 – 4 minutes).



## Screen and PLC navigation

When the M600 is ready to start, the screen below will appear (same as Figure 6)

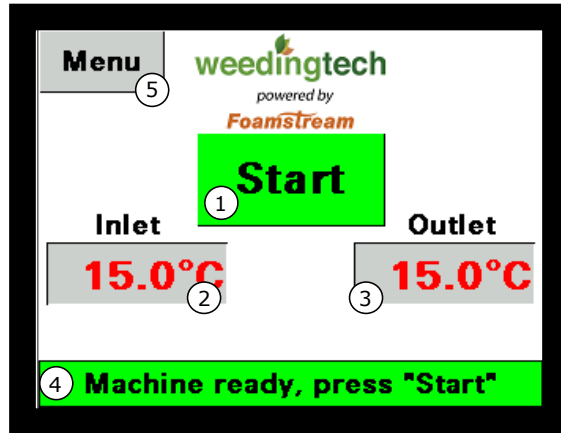

To access the menu, click on the **Menu** (item 5 in Figure 6) button on the top left-hand side of the screen. The screen below will appear.

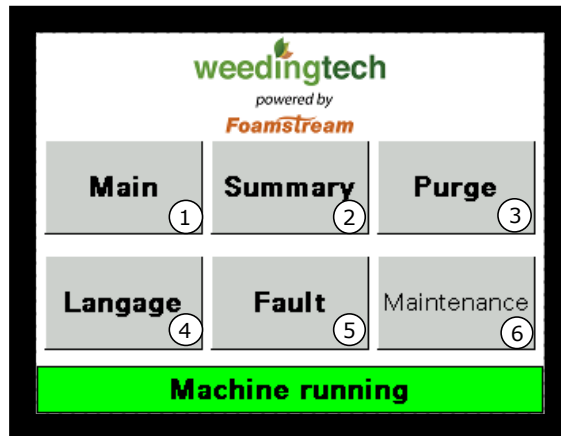
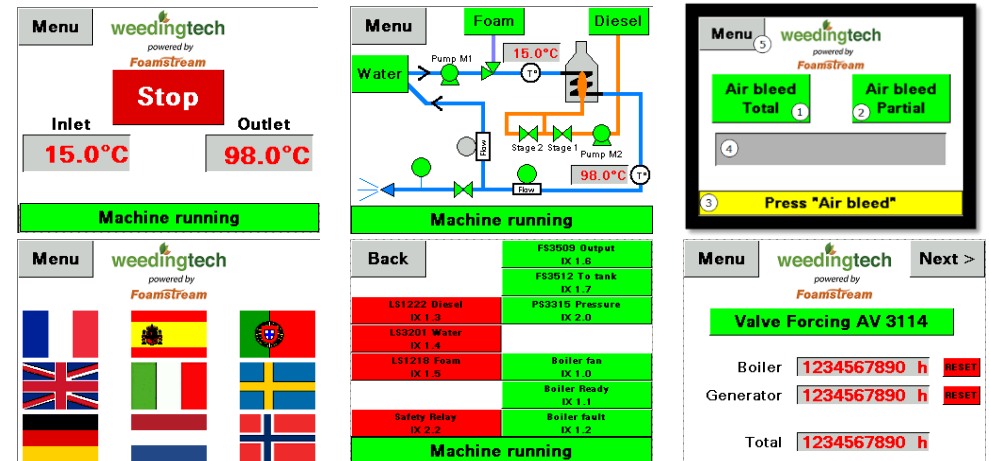

Figure 8 - Menu Screen

Num.	Description
1	Return to main page
2	Go to summary screen
3	Purge (Air bleed)
4	Language and units selection
5	Fault summary panel
6	Maintenance mode

Users have no need to access pages **5** and **6**. Page **6** is restricted by a password. The screens are summarized in the table below.



During the start-up phase, you will be able to check the operation of the various sensors by going on the **Summary** page.